

DL-370 電源保護管 安裝說明書

安裝步驟

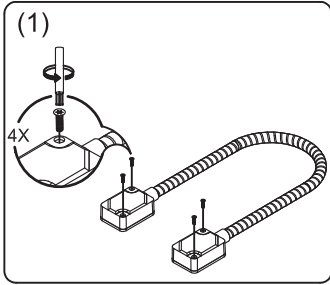

(1) 逆時針旋開上蓋安全螺絲

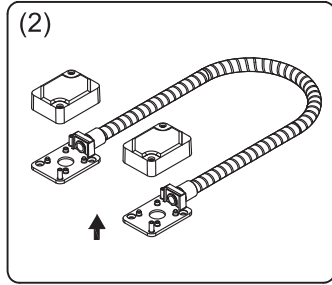

(2) 往上打開上蓋與底座分離

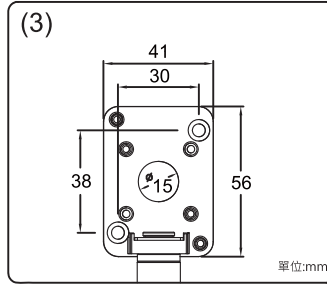

(3) 確定底座與安裝位置是否符合並劃出對應的標記

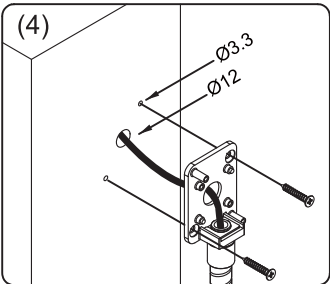

(4) 依照對應的標記分別鑽孔並使用4x25螺絲固定安裝孔

※安裝孔3.3mm

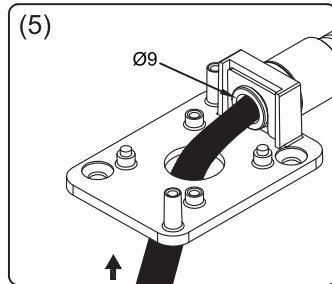

(5) 將電源線穿過底座圓孔與保護管連接並進行測試

※保護管內徑9mm

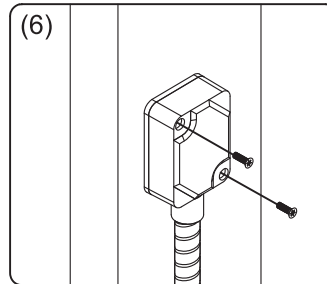

(6) 將上蓋與底座組合後鎖緊安全螺絲，完成電源保護管的安裝

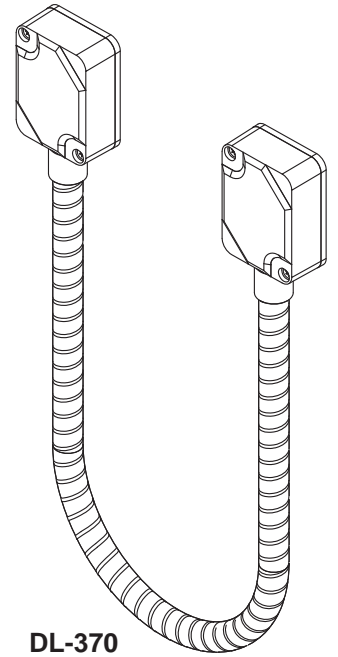

DL-370

DL-370 電源保護管 安裝說明書

安裝步驟

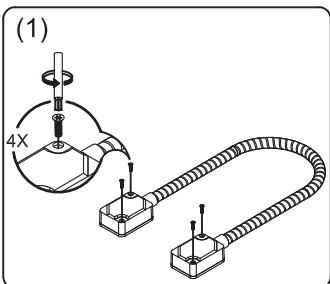

(1) 逆時針旋開上蓋安全螺絲

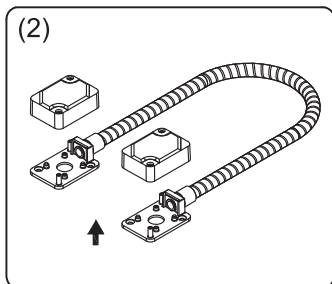

(2) 往上打開上蓋與底座分離

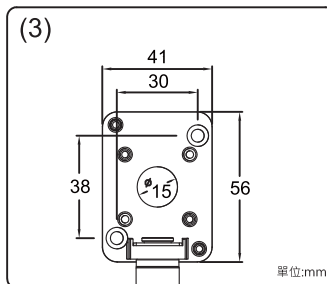

(3) 確定底座與安裝位置是否符合並劃出對應的標記

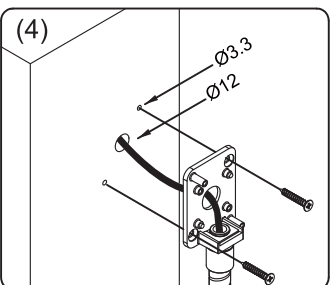

(4) 依照對應的標記分別鑽孔並使用4x25螺絲固定安裝孔

※安裝孔3.3mm

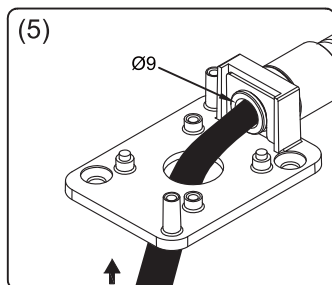

(5) 將電源線穿過底座圓孔與保護管連接並進行測試

※保護管內徑9mm

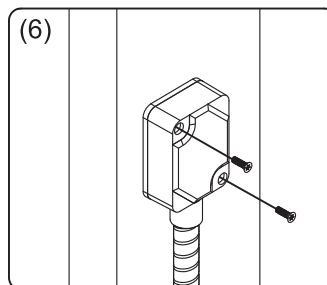

(6) 將上蓋與底座組合後鎖緊安全螺絲，完成電源保護管的安裝

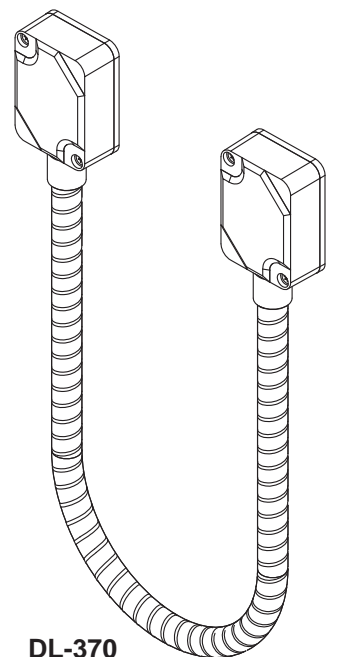

DL-370