



E-Access[®]

E3AK5 Access Control Keypad Instructions



Features

- 1 Administrator, 1000 users
- 2 Access Modes: Use Bluetooth smartphone or enter 4 to 8 digit Passcode to access
- Built-in tamper alarm and buzzer 85dB
- User Management: Add/delete/view user data, grant user access for specific dates or time periods, change user passcode, or enable/disable user keypad entry
- Audit Trail logs for last 1000 events
- The keypad will be disabled for one minute when 3 failed passcode attempts.

LED & Audible Indicators

LED	Keypad Status
Solid Red	Power on, Standby mode
Red Flashing	Bluetooth is connecting
Green	Unlocked, Door always unlocked
Yellow	Invalid Access, Door always locked

Audible Beeps	Status
1 Short beep	Key press
1 Long beep	Valid Access, Reset is completed
2 Short beeps	Login completed
3 Short beeps	Incorrect Passcode, Login failure, Forget to press # after entering Passcode within 30 seconds.
Constant beeping	Bluetooth keypad vandalized, Door Sensor is ON

Specifications

- Voltage (Input): 12 to 24 VDC
- Current Draw:
Standby current: 16mA@12VDC, 7mA@24VDC
Working current: 18mA@12VDC, 9mA@24VDC
- Bluetooth Module: BLE 4.2
- Operating distance : Up to 50 meters(164 ft) without blocking by metal or concrete wall/door frame.
- Smartphone Compatibility: Android 5.0 to 8.0, iOS 9.0 and up
- Finish: Stainless Steel
- Dimensions: 5-1/4"×3-9/16"×1-11/16"
(134×90×43 mm)

2018/04/16 ver. 1.2



T +886-2-2205-2228
F +886-2-2205-2225

E info@anxell.com
W www.anxell.com

ANXELL TECHNOLOGY CORPORATION
No.304, Xinsu Rd., Xinzhuang Dist., New Taipei City 242, Taiwan (R.O.C.)

E3AK5 Installation

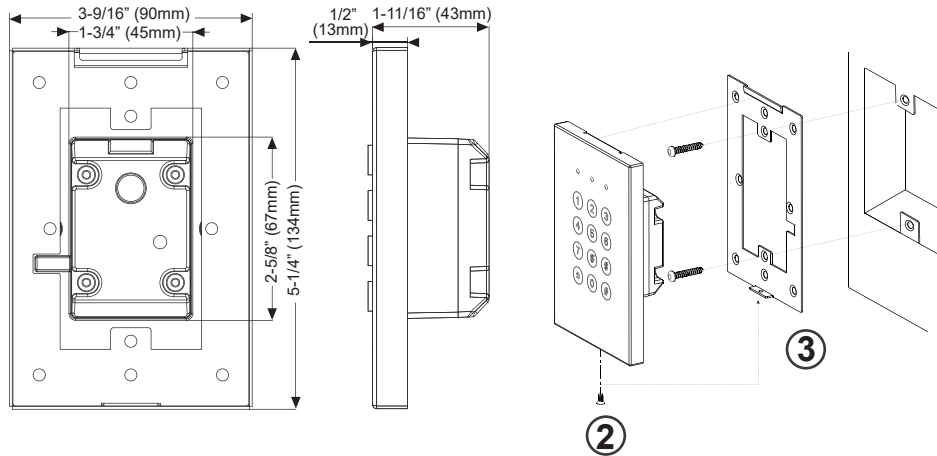

E3AK5 Installation:

- ① Check and measure dimensions.
- ② Unscrew the bottom screw of E3AK5 Keypad.
- ③ Slide down the back mounting metal plate of E3AK5 to release the back metal plate.
- ④ Install the mounting metal plate by using truss head Phillips screws with anchor bolts to mount the metal plate on the wall.
- ⑤ Check wiring diagram before connecting wires.
- ⑥ Mount E3AK5 Keypad slightly from the top of metal plate and clip it to attach fully to the metal plate.
- ⑦ Finish E3AK5 Keypad installation.

E3AK5 Screw Packs		
 x6	 x6	 x1
 x10	 x1	

Crimp connectors included:

Crimp Connector 

Use a pair of crimping pliers designed to crimp insulated connectors. Place the crimp connector into the compression slot. Be sure the crimping jaws are positioned over the stripped portion of the wire. Squeeze the handles together with enough force to crush the end of the butt splice.

E3AK5 Wiring Diagram

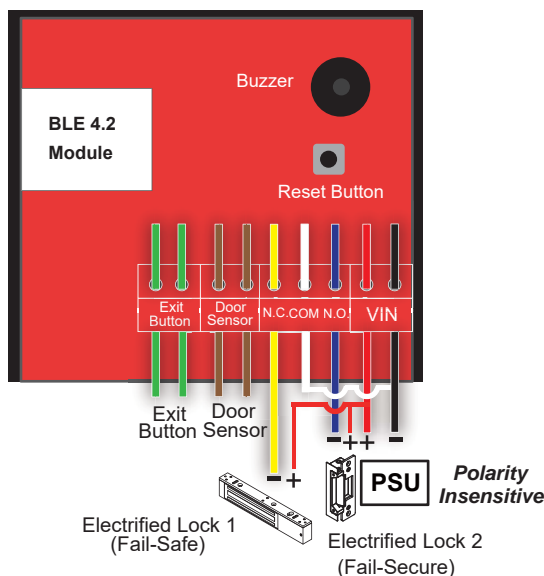

Reset Procedures

How to Reset a Bluetooth Keypad with Reset Button on the PC board?

1. Power off Access Control Keypad/Reader.
2. Press and hold the Reset Button, then power on.
3. Hear a long beep to complete resetting procedures.
4. Login as Admin and check all users, audit trail events are all cleared and all data is reset to factory default setting, except device name and device time.

2018/04/16 ver. 1.2



T +886-2-2205-2228
F +886-2-2205-2225

E info@anxell.com
W www.anxell.com

ANXELL TECHNOLOGY CORPORATION

No.304, Xinshu Rd., Xinzhuang Dist., New Taipei City 242, Taiwan (R.O.C.)

E3AK5 APP

(a) Download E3AK APP



Download the E3AK APP to set up. Scan QR code on the left or go to Apple Store or Google Play depending on what kind of smartphone you use.

(b) E3AK App for Administrator and Users

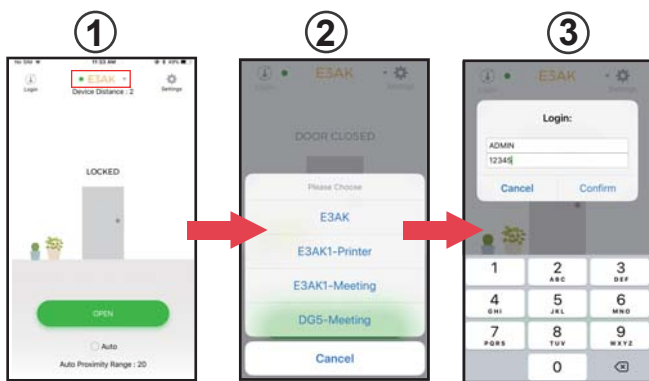

Press ① to go to Devices page. Select the designated Bluetooth device as shown on ②.

Login first,

• Administrator : Enter Admin ID and Admin Passcode to login.

Default Admin ID: ADMIN

Default Admin Passcode: 12345

• User : Enter User ID and User Passcode to login.

User ID and User Passcode are given by the Administrator.

[Note]

1. Administrator ID "ADMIN" can not be changed. we recommend changing Admin's default passcode "12345" right after you login as the Admin. Go to settings page, tap Admin Passcode to Edit Admin Passcode.

2. Admin passcode and User passcode are also used as keypad Passcode access.

(c) Administrator Settings Page

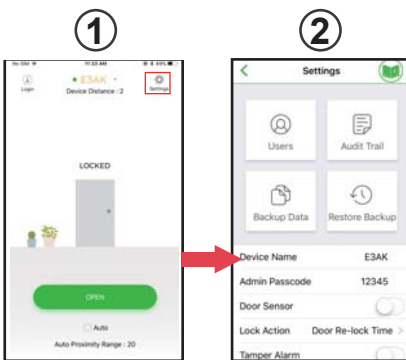

Press  ① to go to "Settings" page as shown ②.

(d) Administrator Settings Page Users Management Add / Delete / Edit User Information

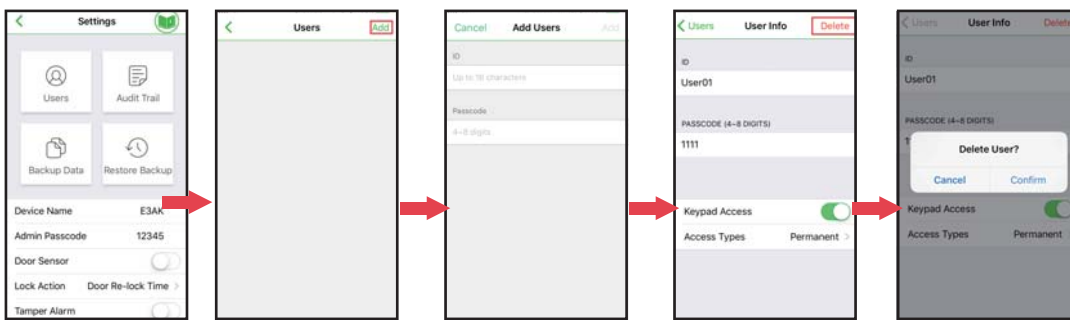

Press "Users" to edit individual user's information. You can add a user, delete a user, and select individual user to give specific settings.

2018/04/16 ver. 1.2







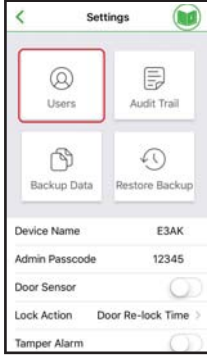
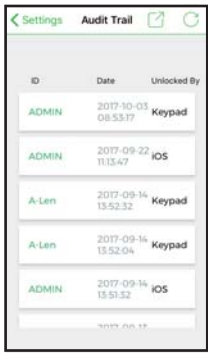

T +886-2-2205-2228
F +886-2-2205-2225

E info@anxell.com
W www.anxell.com

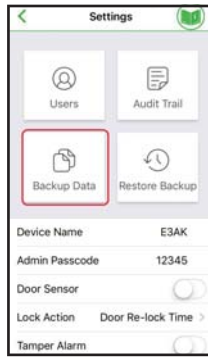
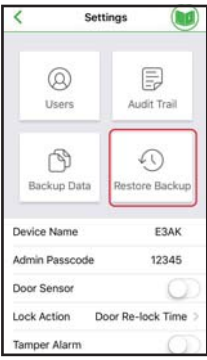
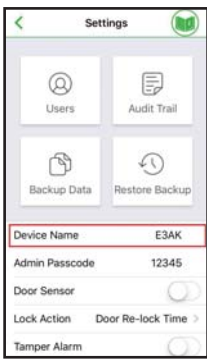
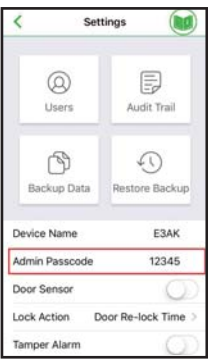
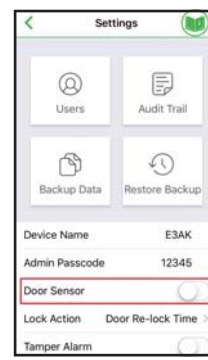
ANXELL TECHNOLOGY CORPORATION
No.304, Xinshu Rd., Xinzhuang Dist., New Taipei City 242, Taiwan (R.O.C.)

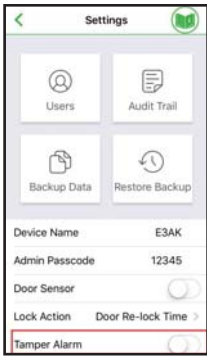
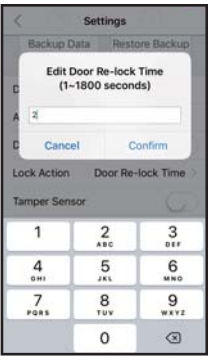
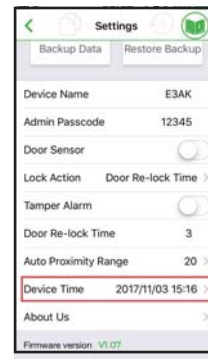

Administrator Settings Page Introductions :

<h3>Users</h3>  <p>You can Add / Delete / Edit user information.</p>	<h3>Audit Trail</h3>  <p>Audit Trail is tracking last 1000 event logs, including Tamper Alarm. Audit Trail can be exported in an excel file. Tap  to export all events to excel file. Tap  to refresh all events.</p>	<h3>Backup Data</h3>  <p>Backup Data is to backup all data to Administrator's phone and can be restored except Device Name, Audit Trail logs and Device Time.</p>	<h3>Restore Backup</h3>  <p>You can restore the last backup data to a new Access Control Keypad / Reader.</p>
<h3>Device Name</h3>  <p>Device name can be edited as a model number, Office, Front door, Gate, etc.</p>	<h3>Admin Passcode</h3>  <p>12345 is Admin default passcode. It's important to change your Admin passcode immediately.</p>	<h3>Door Sensor</h3>  <p>You can enable Door Sensor when you connect to a closed-circuit magnetic sensors or a monitored door lock that has door sensor (or lock sensor) outputs to monitor the open or closed state of a door.</p>	<h3>Lock Action</h3>  <p>3 options. You can choose Door Re-lock Time, Door Always Unlocked and Door Always Locked.</p>
<h3>Tamper Alarm</h3>  <p>Tamper Alarm is deactivated by default. You can activate Tamper Alarm. If the device is vandalized, the tamper alarm will howl immediately and won't go off until it's switched off by Administrator.</p>	<h3>Door Re-lock Time</h3>  <p>You can set the door re-lock time interval between 1 to 1800 seconds.</p>	<h3>Device Time</h3>  <p>Make sure to set up Device Time precisely as your current time zone of where you are. It helps having correct and precise access data and information.</p>	<h3>About Us</h3>  <p>Tap " About Us " to show Device Model, APP version, website and E-Mail information.</p>

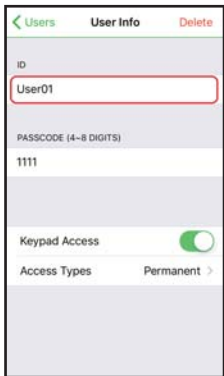
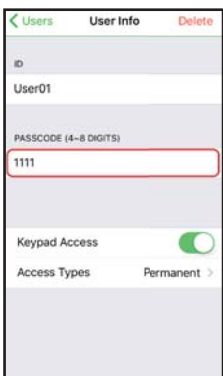
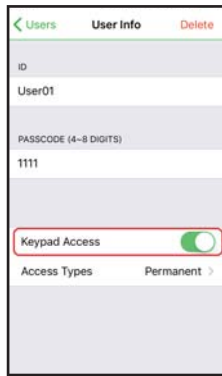
Administrator Settings Pages – Users Management Edit User Information

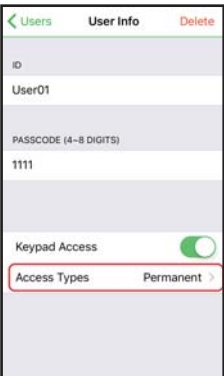
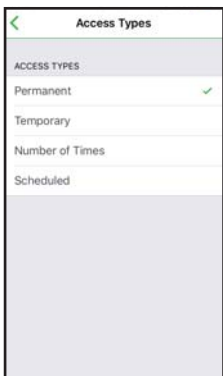
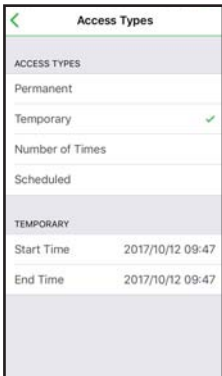
<p style="text-align: center;">ID</p>  <p style="text-align: center;">Tap user " ID" to Edit ID.</p>	<p style="text-align: center;">PASSCODE</p>  <p style="text-align: center;">Tap user "PASSCODE" to Edit PASSCODE.</p>	<p style="text-align: center;">Keypad Access</p>  <p style="text-align: center;">You can enable/disable keypad access for a user.</p>
--	---	---

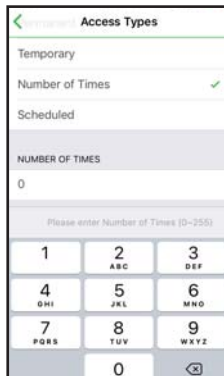
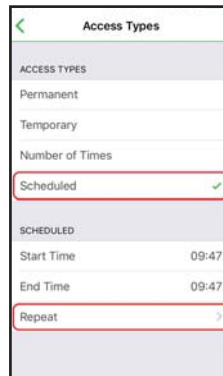
<p style="text-align: center;">Access Types</p>   <p style="text-align: center;">Tap "Access Types" to choose Permanent, Temporary, Number of Times, or Scheduled. The App is set to give Permanent access by default.</p>	<p style="text-align: center;">Temporary</p>  <p style="text-align: center;">Tap " Temporary" to set specific access time periods.</p>
---	---

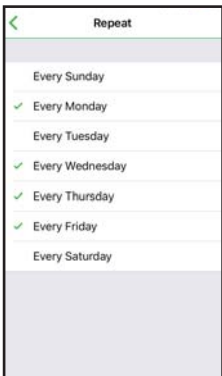
<p style="text-align: center;">Number of Times</p>  <p style="text-align: center;">Tap "Number of Times" to set number of access granted to user.</p>	<p style="text-align: center;">Scheduled</p>    <p style="text-align: center;">Tap "Scheduled" to assign repeatedly access on specific days and hours for a certain period of time. This setting is useful for house cleaners and other guests that need temporary access on regular basis.</p>
---	--

E3AK5 APP

Auto Proximity Range Adjustment and Auto unlock Function Administrator Interface:

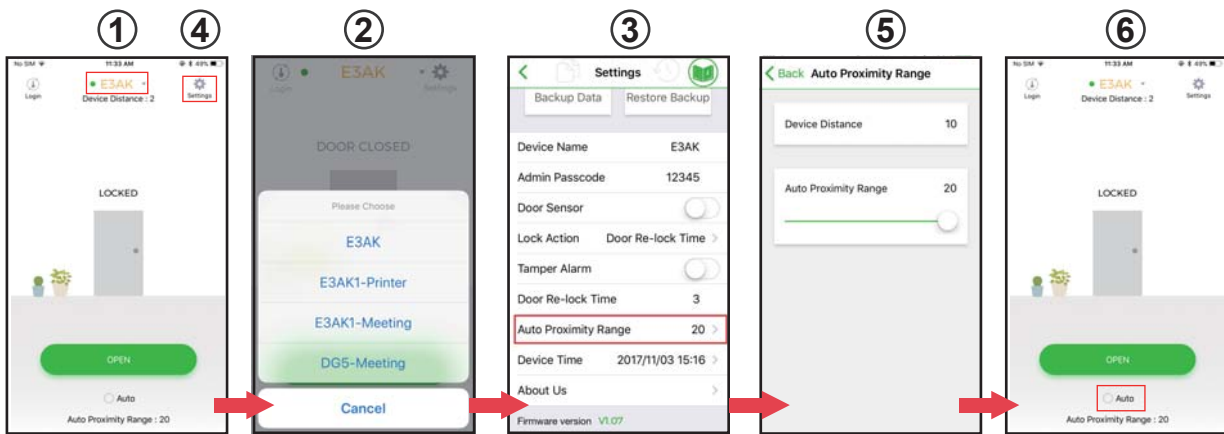

figure ① Tap ① to go to Device list page as ②.

figure ② Select the desired Bluetooth Access Control Keypads/Readers around you.

Tap ④ Settings button to go into Settings page as figure ③ to select "Proximity Read Range"

figure ⑤ Adjust "Auto Proximity Range" for Auto unlock function between 0 to 20.

figure ⑥ Back to the main page. Tap "Auto" to enable Auto unlock function to access.

Auto Proximity Range Adjustment and Auto unlock Function User Interface:

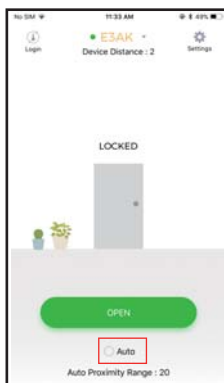
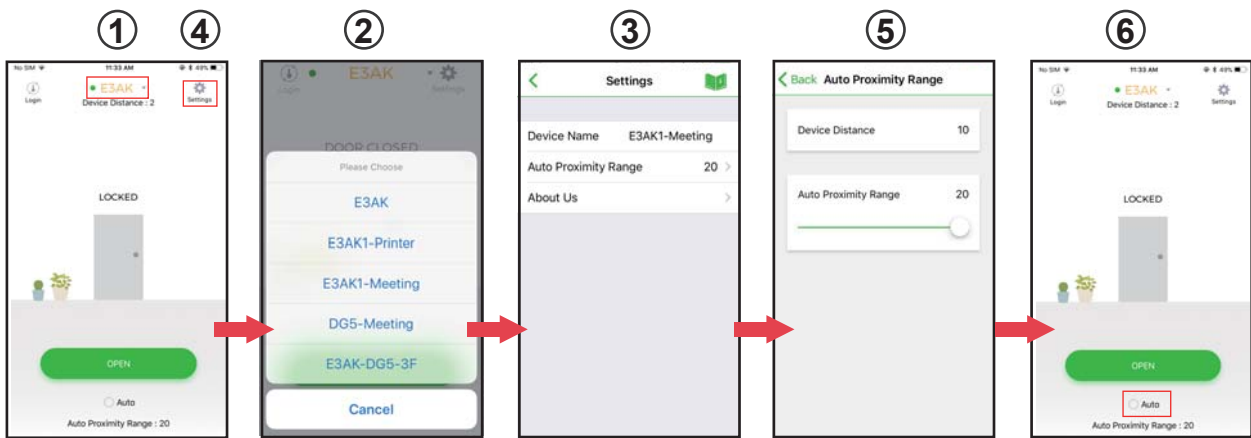

figure ① Tap ① to go to Device list page as ②.

figure ② Select the desired Bluetooth Access Control Keypads/Readers around you.

Tap ④ Settings button to go into Settings page as figure ③ to select "Proximity Read Range"

figure ⑤ Adjust "Auto Proximity Range" for Auto unlock function between 0 to 20.

figure ⑥ Back to the main page. Tap "Auto" to enable Auto unlock function to access.

Note:

Make sure to disable Auto before pressing  to enter Settings page.

2018/04/16 ver. 1.2



T +886-2-2205-2228
F +886-2-2205-2225

E info@anxell.com
W www.anxell.com

ANXELL TECHNOLOGY CORPORATION

No.304, Xinshu Rd., Xinzhuang Dist., New Taipei City 242, Taiwan (R.O.C.)

E3AK5 Operation Instructions

Note:

Stand next to the E3AK5 Bluetooth keypad when you want to connect the Smartphone to unlock or login, the Bluetooth keypad can detect signal up to 50 meters (164 ft) distance. The response time of Bluetooth signal may vary depend on various mobile device models.

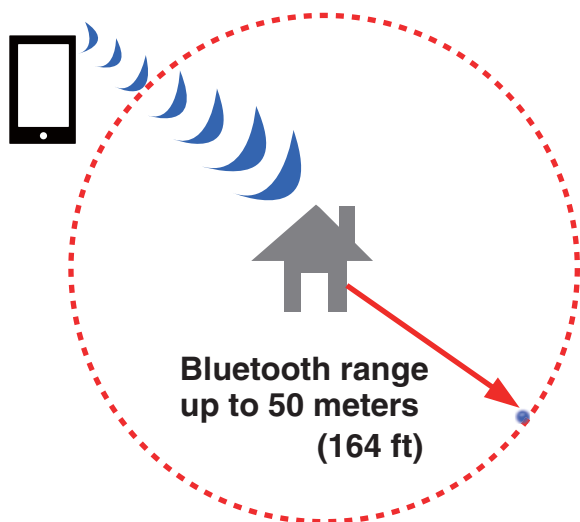

Keypad Passcode Access

After login is complete, you can enter your Passcode plus “#” to unlock the door.

For example:

If your passcode is 12345, enter 1 2 3 4 5 # .

2018/04/16 ver. 1.2



T +886-2-2205-2228
F +886-2-2205-2225

E info@anxell.com
W www.anxell.com

ANXELL TECHNOLOGY CORPORATION
No.304, Xinshu Rd., Xinzhuang Dist., New Taipei City 242, Taiwan (R.O.C.)

Warranty

This ANXELL product is warranted against defects in material and workmanship while used in normal service for a period of one year from the date of sale . ANXELL' s obligation is limited to the repair or replacement of any defective part if the unit is returned, transportation prepaid, to ANXELL.

Warranty is void if damage is caused by or attributed to acts of God, physical or electrical misuse or abuse, neglect, repair, or alteration, improper or abnormal usage, or faulty installation, or if for any other reason ANXELL determines that such equipment is not operating properly as a result of causes other than defects in material and workmanship.

NOTICE:

The information and specifications printed in this manual are current at the time of publication. However, the ANXELL policy is one of continual development and improvement. For this reason, ANXELL reserves the right to change specifications without notice.

Copyright ©2017 ANXELL TECHNOLOGY CORPORATION. All rights reserved. This material may not be reproduced or copied, In whole or in part, without the written permission of ANXELL.

