

A值表示電磁鎖安裝在門框時所需的寬度，各等級電磁鎖所需的最小寬度見下附表。當門框不足時，須加裝L型輔助架。

| 電磁鎖等級 | "A"值 | 選配的輔助架 |
|----------|------|------------------------|
| 300 LBS | 38mm | L-150, L-EM150... |
| 600 LBS | 42mm | L-300, L-10001ST... |
| ● 800LBS | 48mm | L-750, L-350, L-400... |
| 1200 LBS | 60mm | L-500, L-600... |

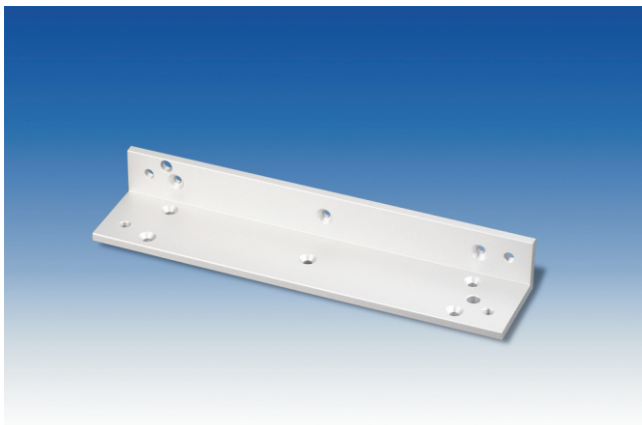

運用的電磁鎖型號:10006

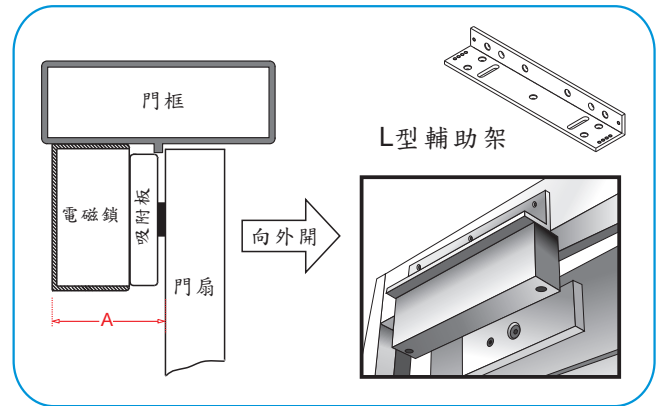
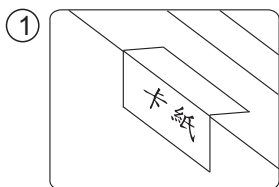
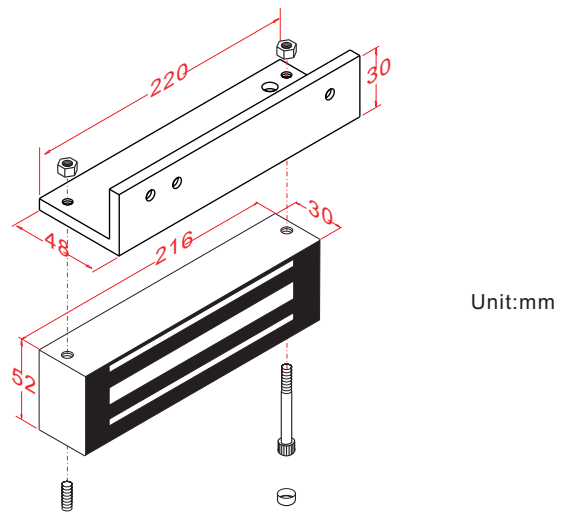

安裝卡紙沿虛折成直角

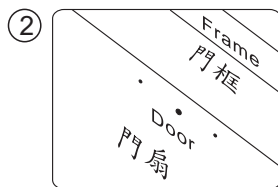

關上門，確定安裝位置後，依照卡紙上標示吸附板與電磁鎖的孔位，標記之。

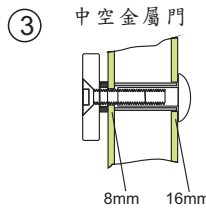

先鑽8mm孔貫穿門扇再從門外側擴大為12.7mm孔

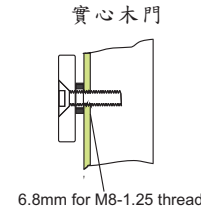

門內先鑽6.8mm孔金屬板攻M81.25mm的螺絲牙

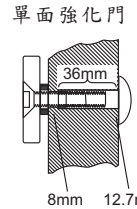

先鑽8mm孔貫穿門扇再從門外側擴大為12.7mm孔，深度為36mm

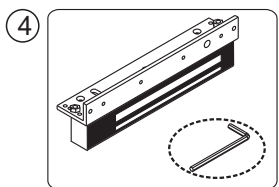

使用六角板手組合電磁鎖與L輔助架(二者輕輕鎖著即可)

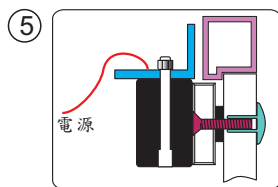

送電給電磁鎖，對準吸附板吸住，再把L輔助架貼緊門框。

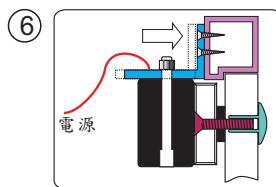

L輔助架固定門框

完成

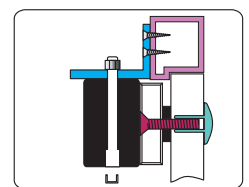

測試無誤後蓋上塞頭