

A值表示電磁鎖安裝在門框時所需的寬度，各等級電磁鎖所需的最小寬度見下附表。當門框不足時，須加裝L型輔助架。

電磁鎖等級	"A"值	選配的輔助架
● 300 LBS	38mm	L-150, L-EM150...
600 LBS	42mm	L-300, L-10001ST...
800LBS	48mm	L-750, L-350, L-400...
1200 LBS	60mm	L-500, L-600...

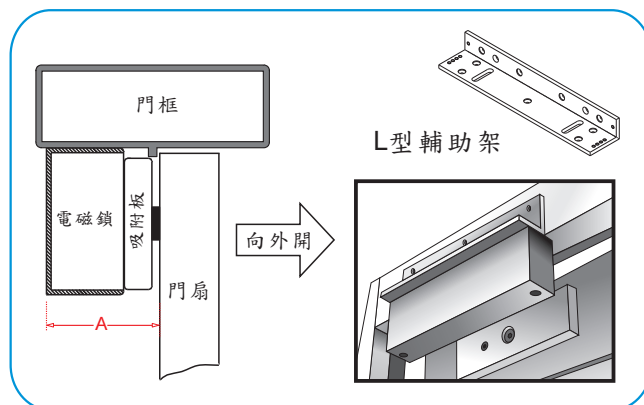

運用的電磁鎖型號: 10003S

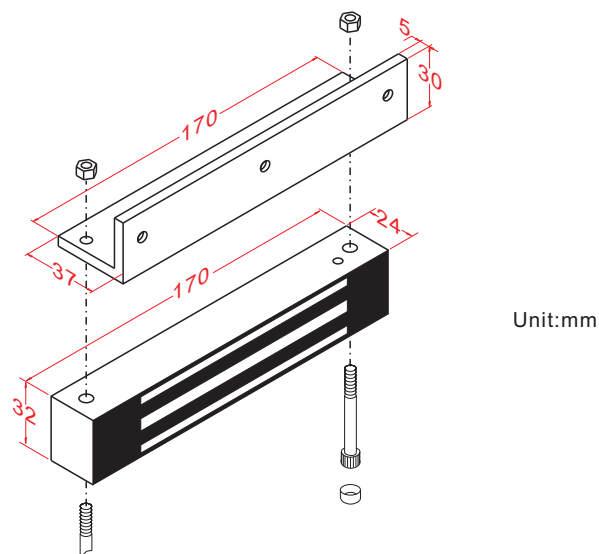

Unit:mm

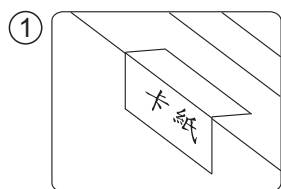

安裝卡紙沿虛折成直角

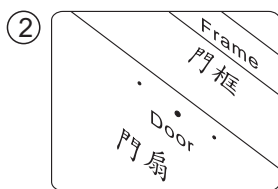

關上門，確定安裝位置後，依照卡紙上標示吸附板與電磁鎖的孔位，標記之。

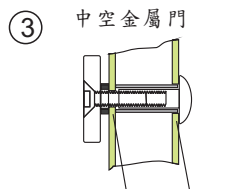

先鑽8mm孔貫穿門扇再從門外側擴大為12.7mm孔

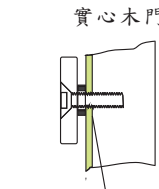

門內先鑽6.8mm孔金屬板攻M81.25mm的螺絲牙

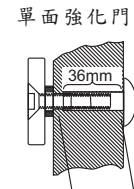

先鑽8mm孔貫穿門扇再從門外側擴大為12.7mm孔，深度為36mm

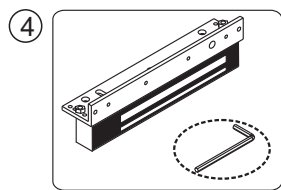

使用六角板手組合電磁鎖與L輔助架(二者輕輕鎖著即可)

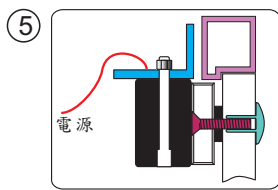

送電給電磁鎖，對準吸附板吸住，再把L輔助架貼緊門框。

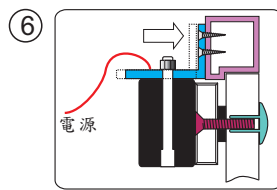

L輔助架固定門框

完成

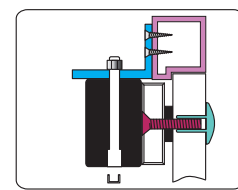

測試無誤後蓋上塞頭