

向內開式門使用

LZ-N10010ST 輔助架

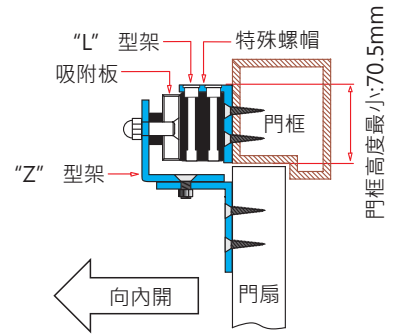

運用的電磁鎖型號: N10001ST系列

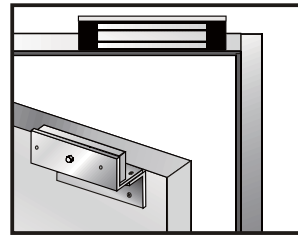
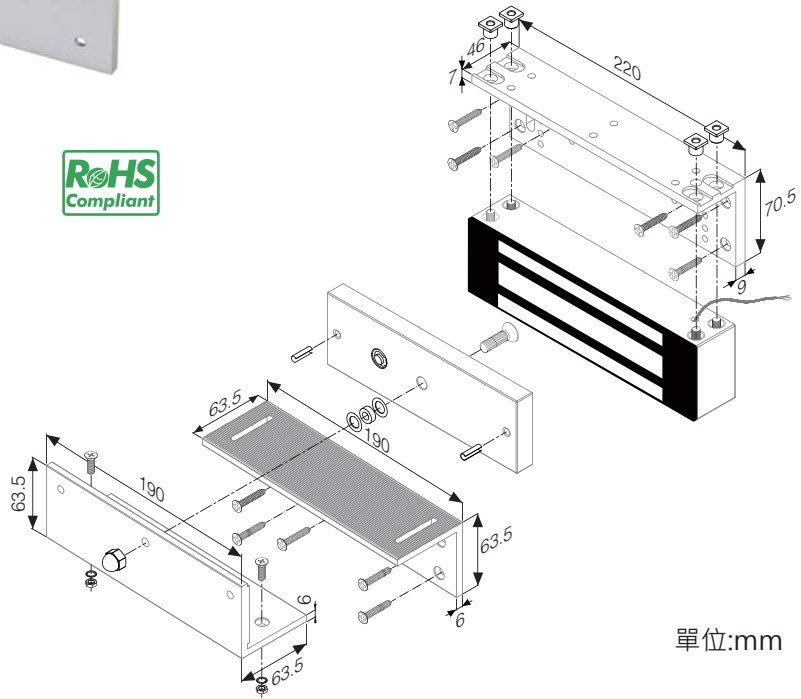

單位:mm

電磁鎖搭配LZ型輔助架安裝於向內開式門

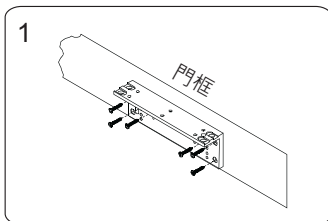

1 在門框適當位置固定LZ型輔助架的L架部分。必須注意不可影響門扇的開關。

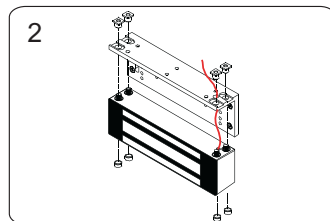

2 用內六角螺絲把電磁鎖固定在L架上。

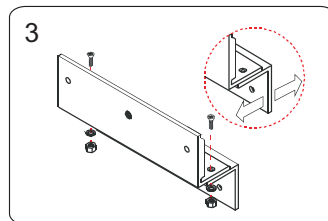

3 組裝LZ型輔助架的Z架部分。必須注意輔助架可以調動。

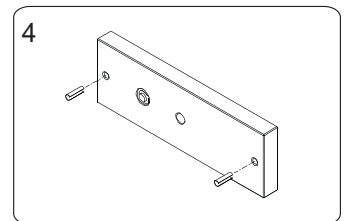

4 把插枒輕輕敲入吸附板。其目的是防止吸附板轉動。

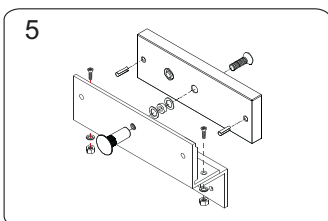

5 依照圖示組合吸附板以及"Z"型輔助架(橡膠墊片務必加入)。

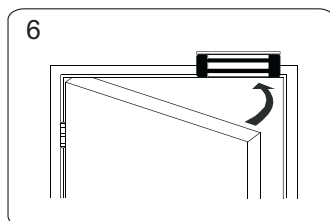

6 關上門，電磁鎖並送電源

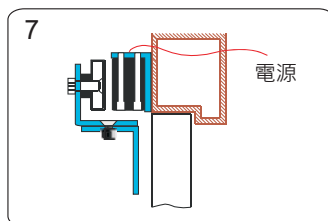

7 吸附板組與電磁鎖正確的吸住後，調整Z型輔助架部分頂到門扇。

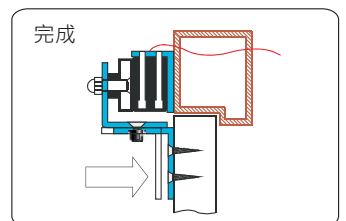

8 鎖緊Z型輔助架，完成。