

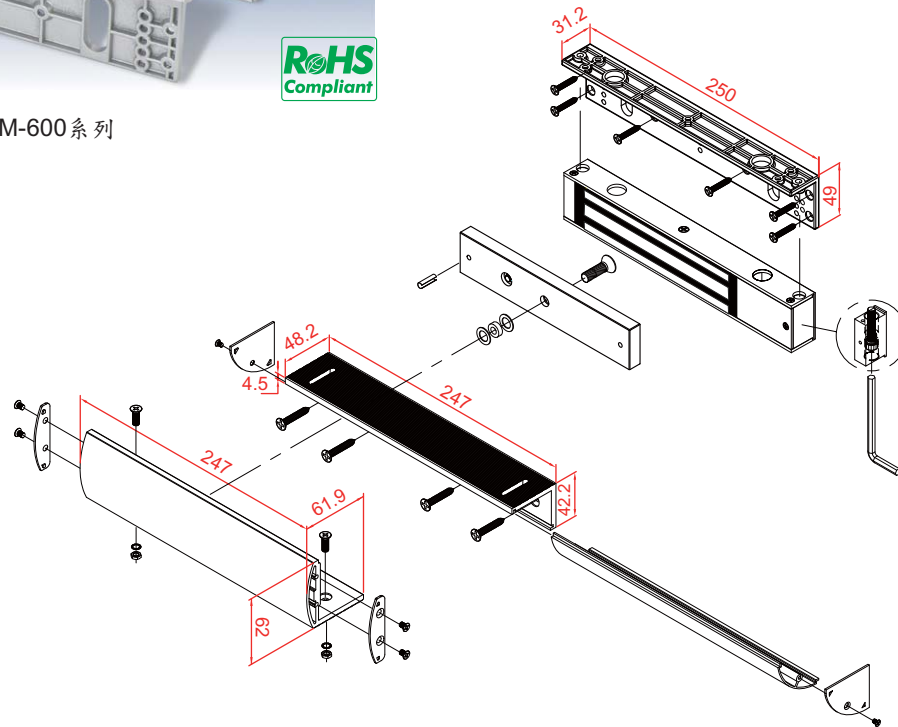

運用的電磁鎖型號: GEM-600系列

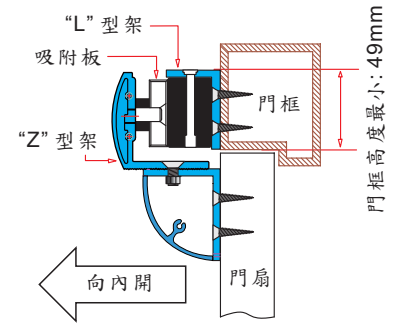
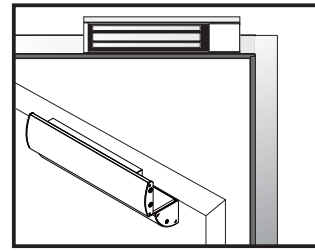

單位:mm

### 電磁鎖搭配LZ型輔助架安裝於向內開式門

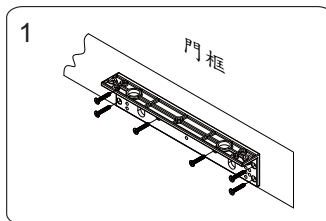

在門框適當位置固定LZ型輔助架的L架部分。必須注意不可影響門扇的開關。

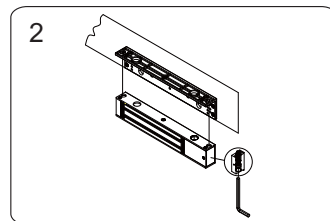

用內六角螺絲把電磁鎖固定在L架上。

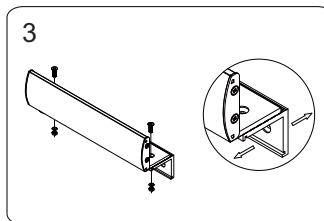

組裝LZ型輔助架的Z架部分。必須注意輔助架可以調動。

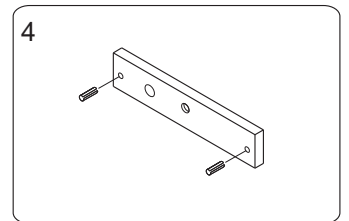

把插枒輕輕敲入吸附板。其目的是防止吸附板轉動。

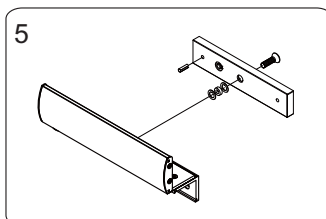

依照圖示組合吸附板以及“Z”型輔助架(橡膠墊片務必加入)

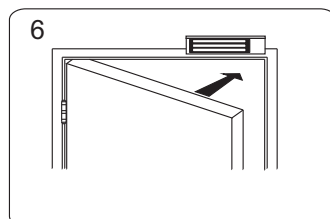

關上門, 電磁鎖並送電源

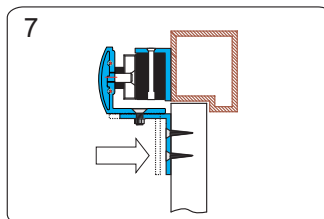

吸附板組與電磁鎖正確的吸住後, 調整Z型輔助架部分頂到門扇。

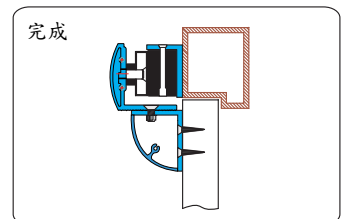

鎖緊Z型輔助架, 完成。