

向外開式門門框過窄使用

L-NH2300 輔助架

A值表示電磁鎖安裝在門框時所需要的寬度，各等級電磁鎖所需要的最小寬度見下表。當門框不足時，須加裝L型輔助架。

電磁鎖等級	A值	選配輔助架
300 LBS	38 mm	L-150, L-EM150
● 600 LBS	42 mm	L-300, L-N10001ST
800 LBS	48 mm	L-750, L-350, L-400
1200 LBS	60 mm	L-500, L-600

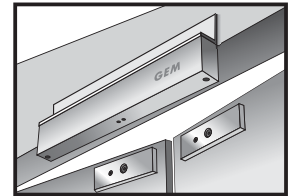
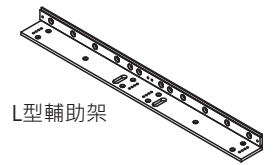
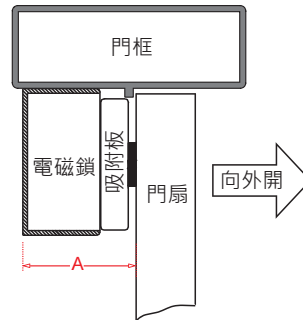

運用的電磁鎖型號: EM-NH2300系列

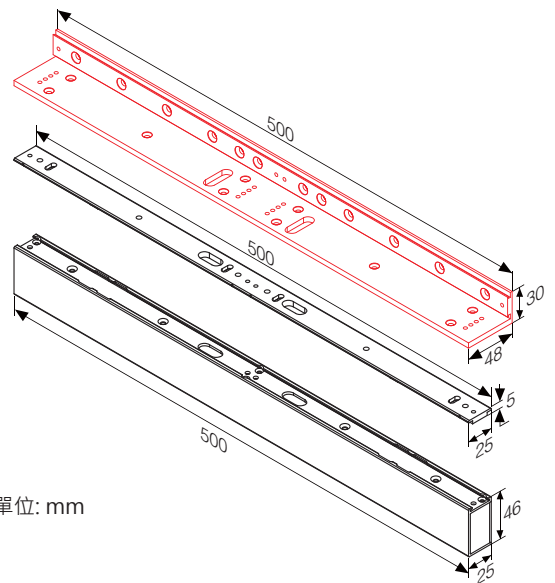

單位: mm

安裝L型輔助架 (向外開式門)

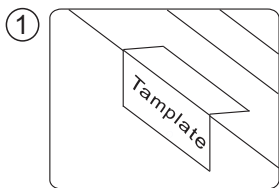

安裝卡紙沿虛折成直角

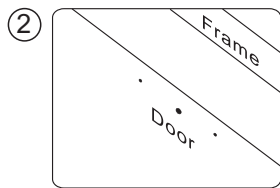

關上門，確定安裝位置後，依照卡紙上標示吸附板與電磁鎖的孔位，標記之。

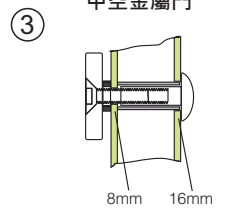

先鑽8mm孔貫穿門扇，再從門外側擴大為12.7mm孔

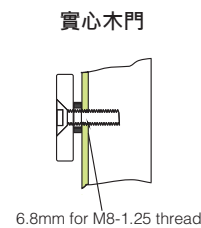

門內先鑽6.8mm孔，金屬板攻M8 1.25mm的螺絲牙

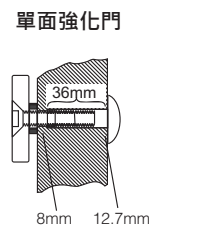

先鑽8mm孔貫穿門扇，再從門外側擴大為12.7mm孔，深度為36mm

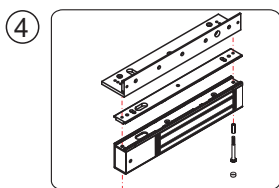

使用六角板手組合電磁鎖與L輔助架(二者輕輕鎖著即可)

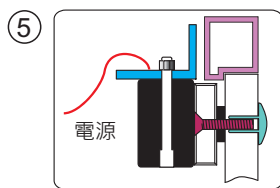

送電給電磁鎖，對準吸附板吸住，再把L輔助架貼緊門框。

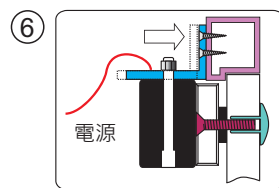

L輔助架固定門框

完成

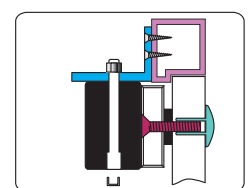

測試無誤後蓋上塞頭