

向外開式門門框過窄使用

# L-GL600 輔助架

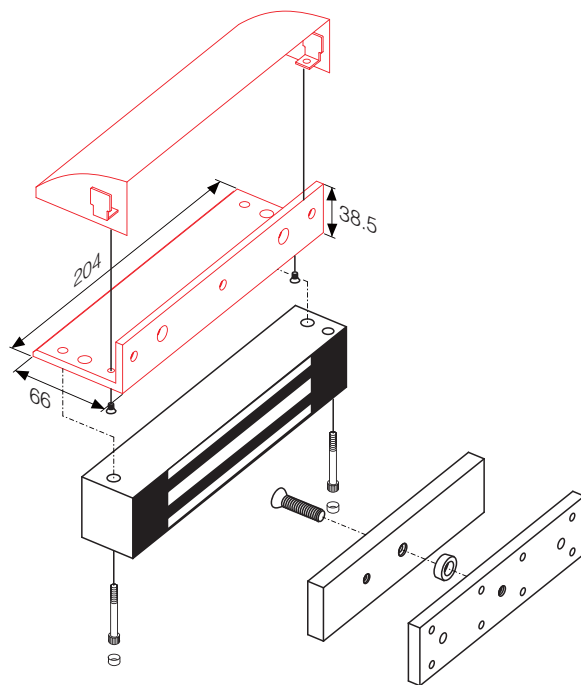

運用的電磁鎖型號: GL600-S



單位: mm

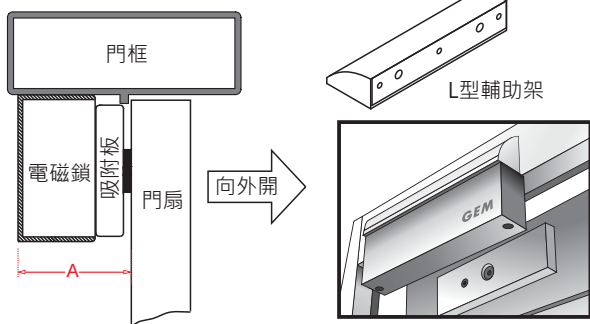

A值表示電磁鎖安裝在門框時所需要的寬度(60mm) · 當門框不足時 · 須加裝L型輔助架。

## 安裝L型輔助架 (向外開式門)

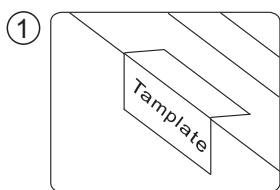

安裝卡紙沿虛折成直角

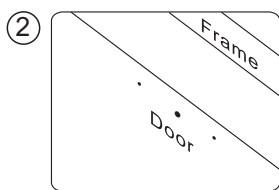

關上門 · 確定安裝位置後 · 依照卡紙上標示吸附板與電磁鎖的孔位 · 標記之。

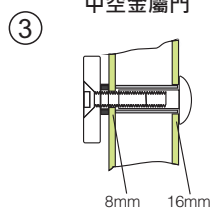

先鑽8mm孔貫穿門扇 · 再從門外側擴大為12.7mm孔

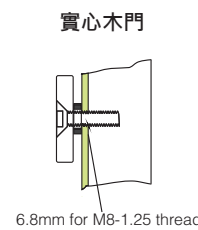

門內先鑽6.8mm孔 · 金屬板攻M8-1.25mm的螺絲牙

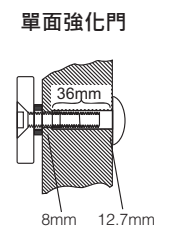

先鑽8mm孔貫穿門扇 · 再從門外側擴大為12.7mm孔 · 深度為36mm

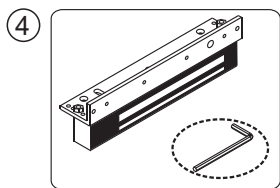

使用六角板手組合電磁鎖與L輔助架(二者輕輕鎖著即可)

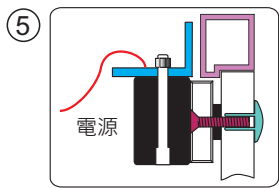

送電給電磁鎖 · 對準吸附板吸住 · 再把L輔助架貼緊門框。

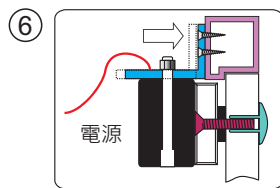

L輔助架固定門框

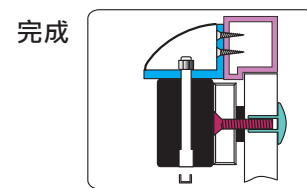

測試無誤後蓋上塞頭