

向內開式門使用

# Z-500N 輔助架

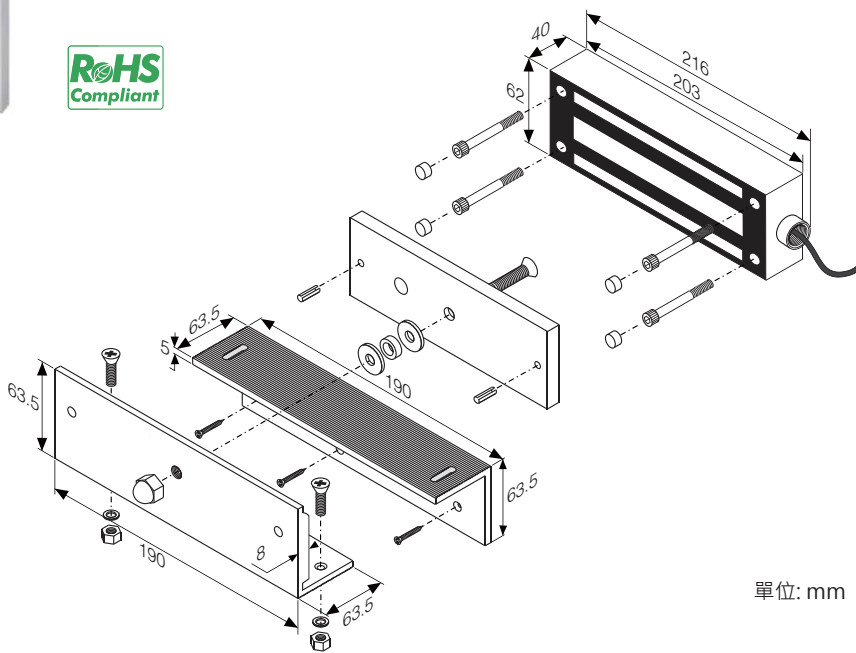

運用的電磁鎖型號: GL-1200F 系列

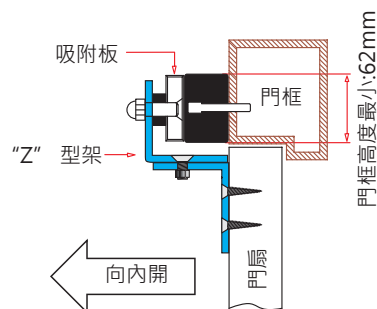
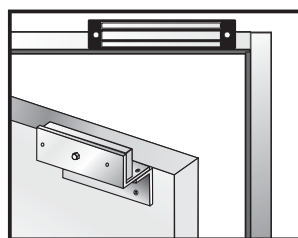

單位: mm

正面孔電磁鎖搭配Z型輔助架安裝於向內開式門

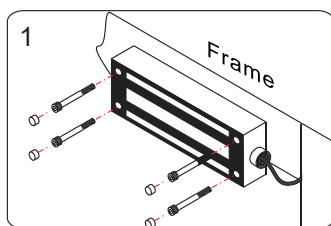

1 在門框適當位置直接固定電磁鎖。必須注意不可影響門扇的開關。

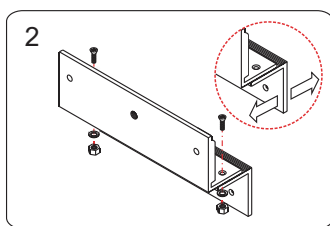

2 組裝輔助架。必須注意輔助架可以調動。

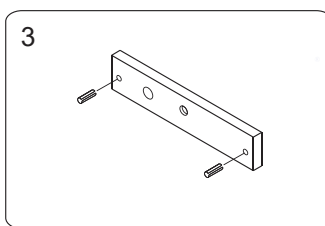

3 把插桿輕輕敲入吸附板。其目的是防止吸附板轉動。

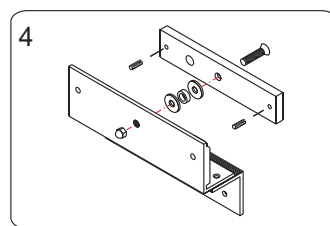

4 依照圖示組合吸附板以及"Z"型輔助架(橡膠墊片務必加入)。

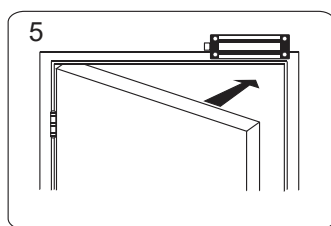

5 關上門，電磁鎖並送電源

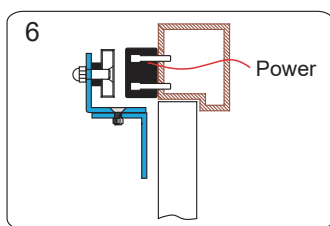

6 吸附板組與電磁鎖正確的吸住後...

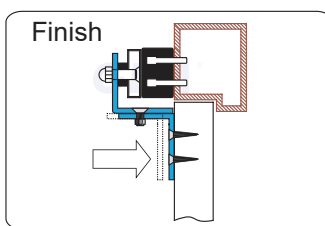

Finish 調整Z型輔助架部分頂到門扇。鎖緊Z型輔助架，完成。