

向內開式門門框過窄使用

LZ-NH2350NAU 輔助架

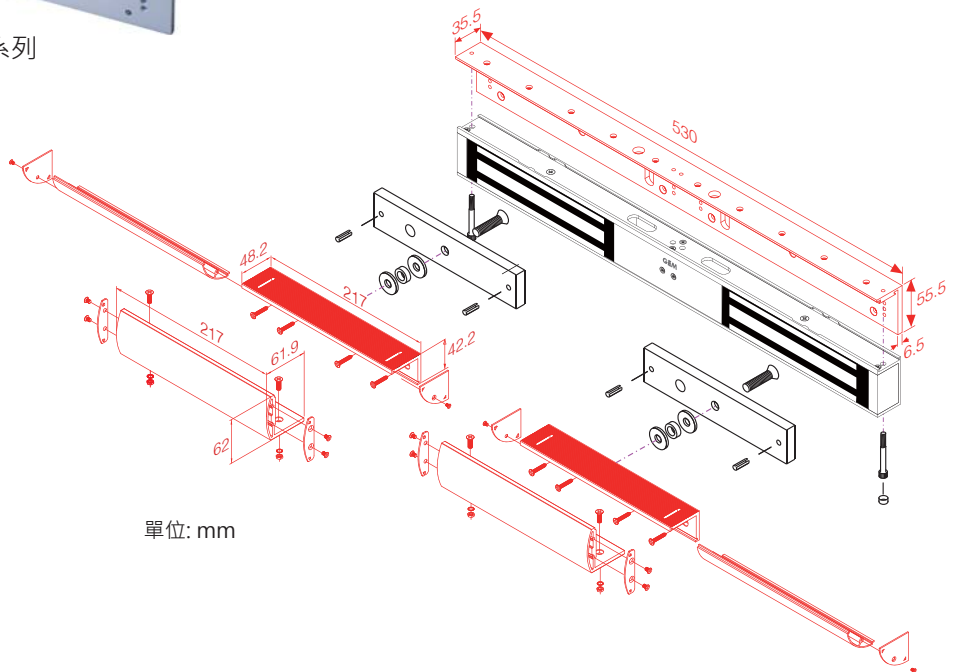

運用的電磁鎖型號: EM-NH2350系列

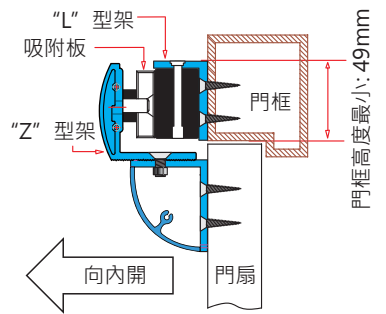
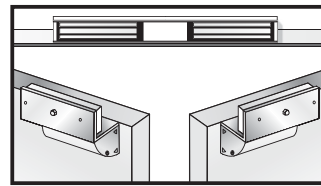

單位: mm

安裝LZ 型輔助架 (向內開式門)

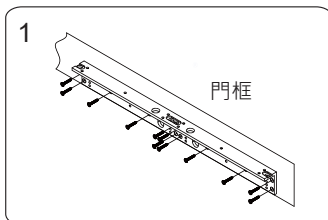

1 在門框適當位置固定LZ型輔助架的L型部分。必須注意不可影響門扇的開關。

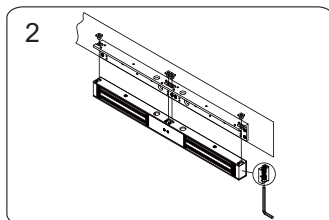

2 用內六角螺絲把電鎖固定在L架上。

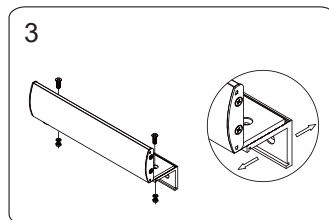

3 組裝LZ型輔助架的Z架部分。必須注意輔助架可以調動。

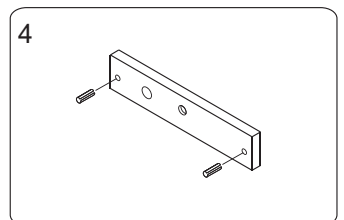

4 把插楔輕輕敲入吸附板。其目的是防止吸附板轉動。

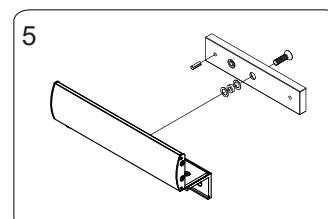

5 依照圖示組合吸附板以及“Z”型輔助架(橡膠墊片務必加入)

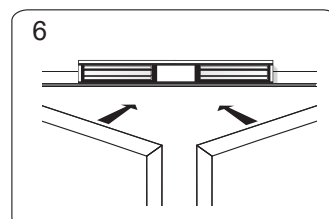

6 關上門，電磁鎖並送電源

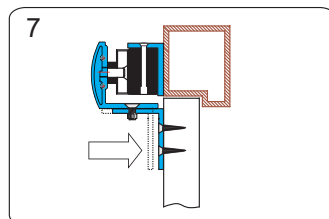

7 吸附板組與電磁鎖正確的吸住後，調整Z型輔助架部分頂到門扇。

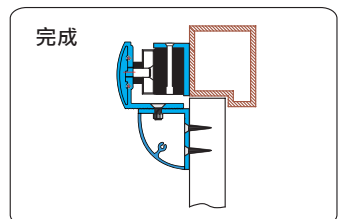

8 鎖緊Z型輔助架，完成。

